

MDP15N075TH

Single N-channel Trench MOSFET 150V, 120A, 7.5mΩ

General Description

The MDP15N075TH uses advanced Magnachip’s MV MOSFET Technology, which provides high performance in on-state resistance, fast switching performance, and excellent quality.

These devices can also be utilized in industrial applications such as Low Power Drives of E-bike (E-Vehicles), DC/DC converter, and general purpose applications.

Features

- $V_{DS} = 150V$
- $I_D = 120A @ V_{GS} = 10V$
- Very low on-resistance $R_{DS(ON)} < 7.5 m\Omega @ V_{GS} = 10V$
- 100% UIL Tested
- 100% Rg Tested

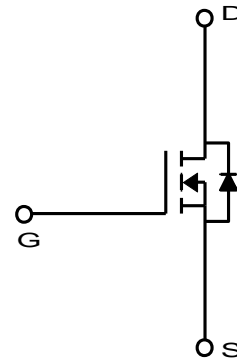
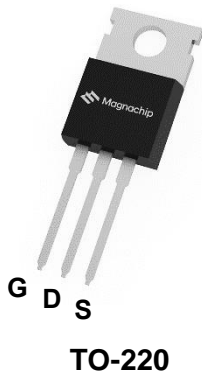

Absolute Maximum Ratings (Ta = 25°C)

Characteristics		Symbol	Rating	Unit
Drain-Source Voltage		V_{DSS}	150	V
Gate-Source Voltage		V_{GSS}	±20	V
Continuous Drain Current ⁽¹⁾	$T_C=25^\circ C$ (Silicon Limited)	I_D	144	A
	$T_C=25^\circ C$ (Package Limited)		120	
	$T_C=100^\circ C$		91	
Pulsed Drain Current ⁽³⁾		I_{DM}	480	
Power Dissipation	$T_C=25^\circ C$	P_D	312	W
	$T_C=100^\circ C$		125	
Single Pulse Avalanche Energy ⁽²⁾		E_{AS}	450	mJ
Junction and Storage Temperature Range		T_J, T_{stg}	-55~150	°C

Thermal Characteristics

Characteristics	Symbol	Rating	Unit
Thermal Resistance, Junction-to-Ambient ⁽¹⁾	$R_{\theta JA}$	62.5	°C/W
Thermal Resistance, Junction-to-Case	$R_{\theta JC}$	0.4	

Ordering Information

Part Number	Temp. Range	Package	Packing	RoHS Status
MDP15N075TH	-55~150°C	TO-220	Tube	Halogen Free

Electrical Characteristics (T_J =25°C)

Characteristics	Symbol	Test Condition	Min	Typ	Max	Unit
Static Characteristics						
Drain-Source Breakdown Voltage	BV _{DSS}	I _D = 250μA, V _{GS} = 0V	150	-	-	V
Gate Threshold Voltage	V _{GS(th)}	V _{DS} = V _{GS} , I _D = 250μA	2.1		4.1	V
Drain Cut-Off Current	I _{DSS}	V _{DS} = 120V, V _{GS} = 0V	-	-	1.0	μA
Gate Leakage Current	I _{GSS}	V _{GS} = ±20V, V _{DS} = 0V	-	-	±0.1	
Drain-Source ON Resistance	R _{DS(on)}	V _{GS} = 10V, I _D = 50A	-	6.2	7.5	mΩ
Forward Transconductance	g _{fs}	V _{DS} = 10V, I _D = 100A	-	70	-	S
Dynamic Characteristics						
Total Gate Charge	Q _g	V _{DS} = 50V, I _D = 50A, V _{GS} = 10V	-	91	-	nC
Gate-Source Charge	Q _{gs}		-	33	-	
Gate-Drain Charge	Q _{gd}		-	25	-	
Input Capacitance	C _{iss}	V _{DS} = 40V, V _{GS} = 0V, f = 1.0MHz	-	6,220	-	pF
Output Capacitance	C _{oss}		-	2,220	-	
Reverse Transfer Capacitance	C _{rss}		-	94	-	
Turn-On Delay Time	t _{d(on)}	V _{GS} = 10V, V _{DS} = 50V, I _D = 50A, R _G = 3.0Ω	-	40	-	ns
Rise Time	t _r		-	28	-	
Turn-Off Delay Time	t _{d(off)}		-	69	-	
Fall Time	t _f		-	20	-	
Gate Resistance	R _g	f=1 MHz	-	3	-	Ω
Drain-Source Body Diode Characteristics						
Source-Drain Diode Forward Voltage	V _{SD}	I _S = 50A, V _{GS} = 0V	-	0.9	1.2	V
Body Diode Reverse Recovery Time	t _{rr}	I _F = 50A, di/dt = 100A/μs	-	153	-	ns
Body Diode Reverse Recovery Charge	Q _{rr}		-	655	-	nC

Note :

- Surface mounted FR-4 board by JEDEC (jesd51-7). Continuous current at T_c=25°C is silicon limited
- E_{AS} is tested at starting T_j = 25°C, L = 1.0mH, I_{AS} = 30.0A, V_{GS} = 10V.
- Pulse width limited by T_{Jmax}

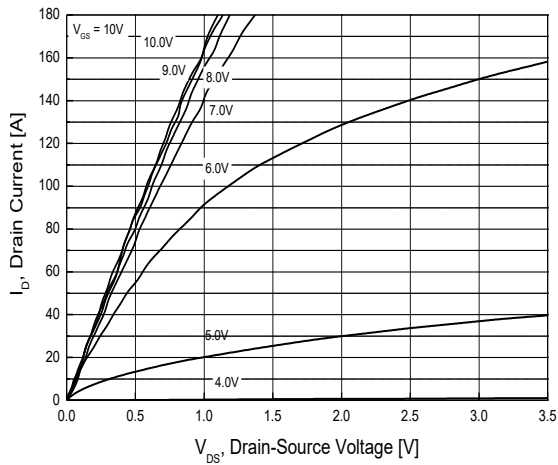

Fig.1 On-Region Characteristics

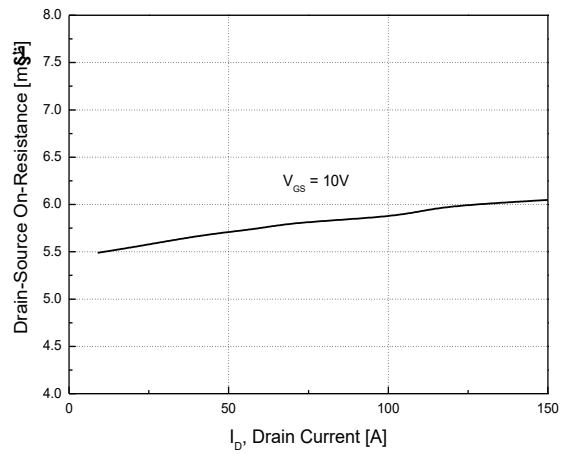

Fig.2 On-Resistance Variation with Drain Current and Gate Voltage

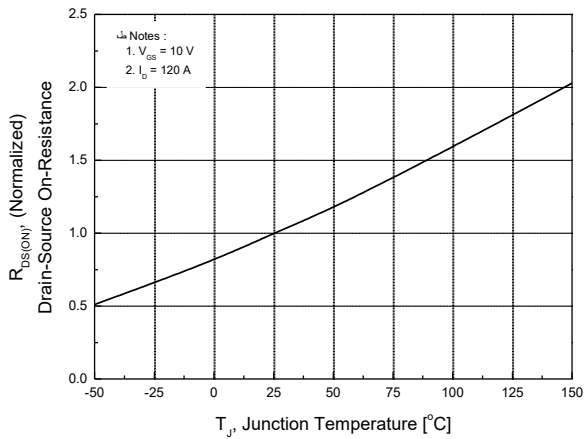

Fig.3 On-Resistance Variation with Temperature

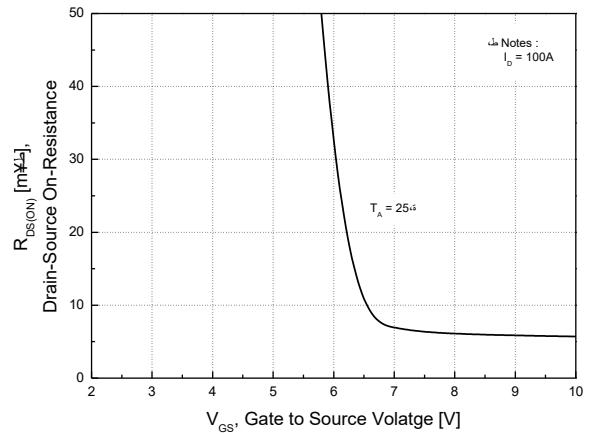

Fig.4 On-Resistance Variation with Gate to Source Voltage

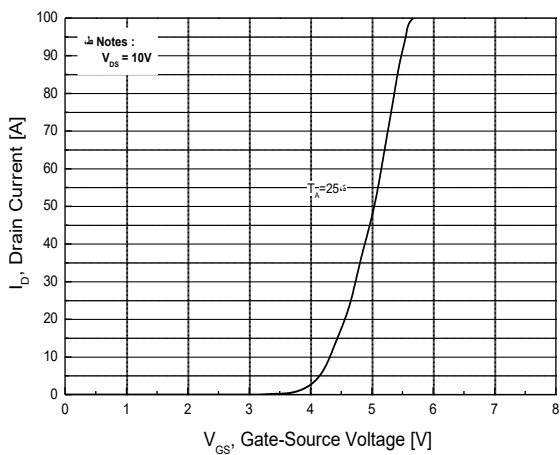

Fig.5 Transfer Characteristics

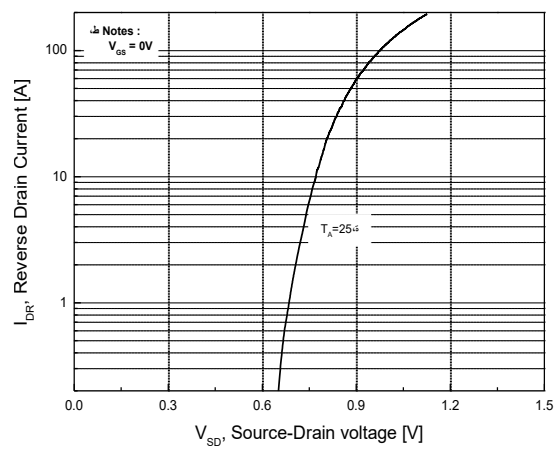

Fig.6 Body Diode Forward Voltage Variation with Source Current and Temperature

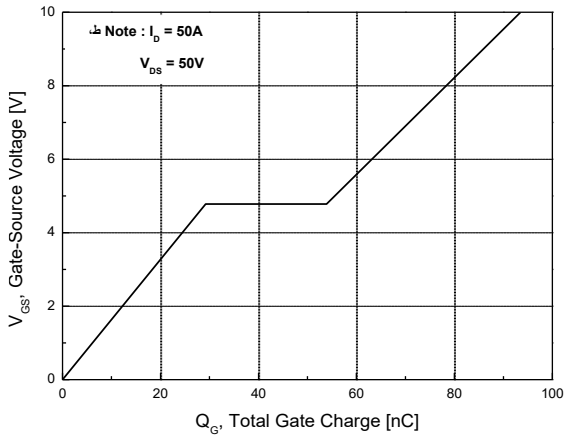

Fig.7 Gate Charge Characteristics

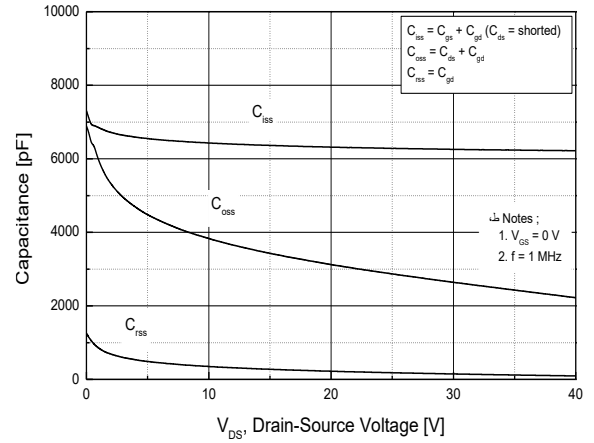

Fig.8 Capacitance Characteristics

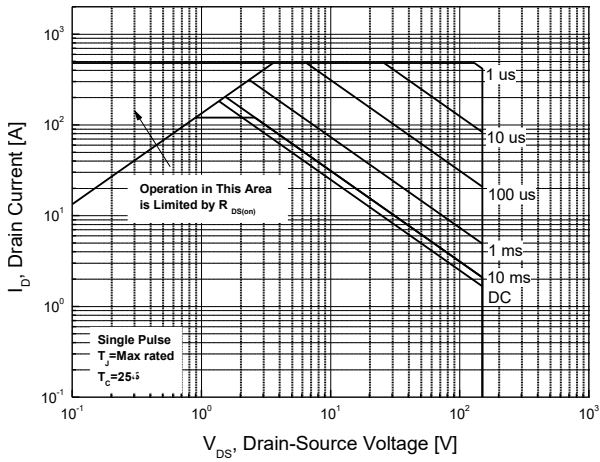

Fig.9 Maximum Safe Operating Area

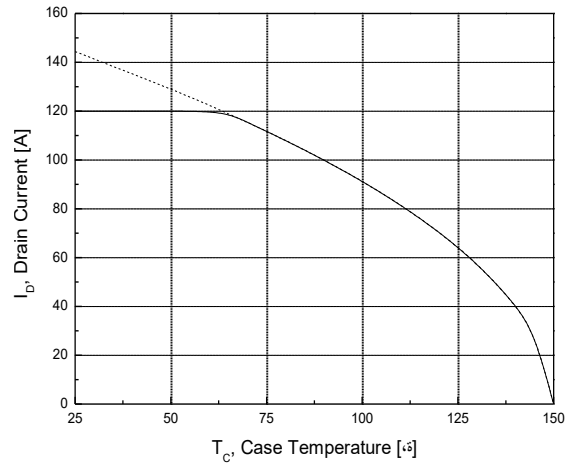

Fig.10 Maximum Drain Current vs. Case Temperature

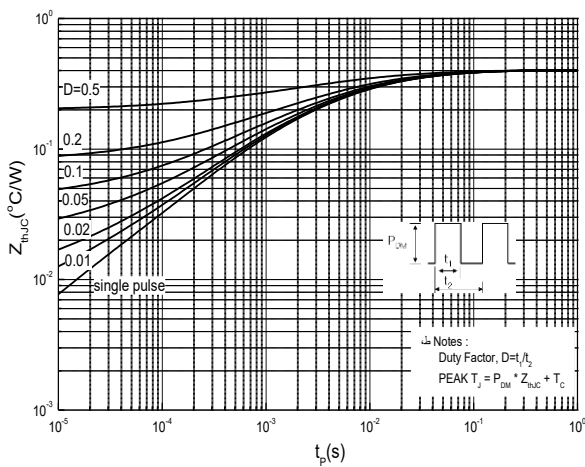
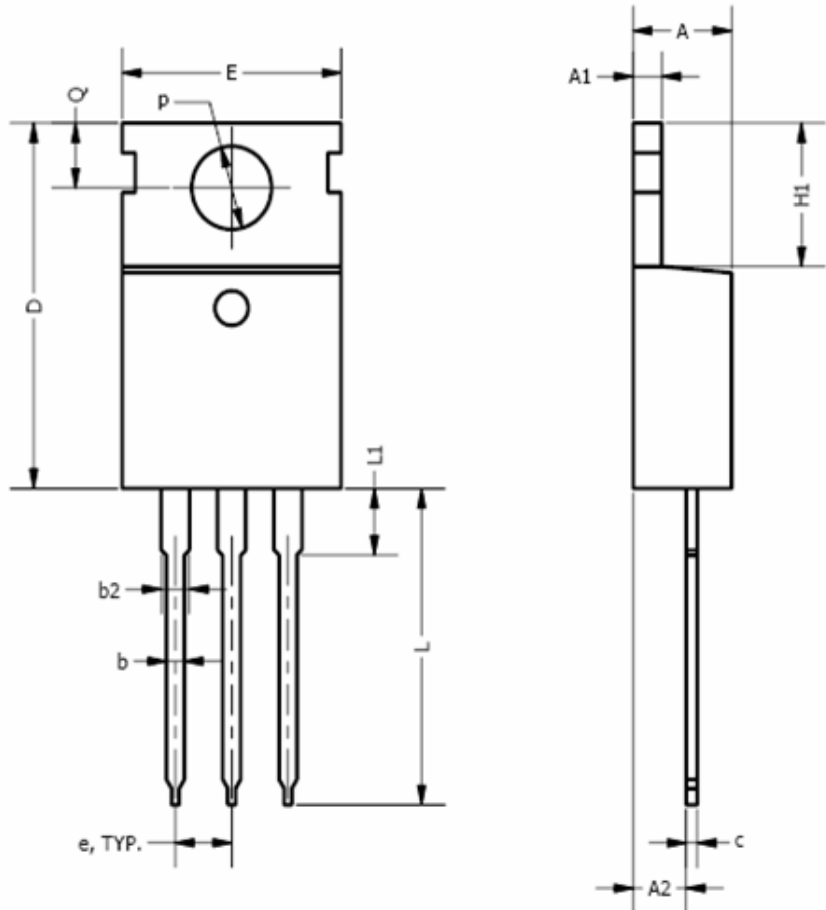

Fig.11 Transient Thermal Response Curve

Package Dimension

TO-220

Dimensions are in millimeters unless otherwise specified



Symbol	Min	Nom	Max
A	3.56		4.83
A1	0.50		1.40
A2	2.03		2.92
b	0.38	0.69	1.02
b2	1.14	1.45	1.78
c	0.36		0.61
D	14.22		16.51
e	2.54 TYP		
E	9.65		10.67
H1	5.84		6.86
L	12.70		14.73
L1			6.35
ϕP	3.53		4.09
Q	2.54		3.43

Note : Package body size, length and width do not include mold flash, protrusions and gate burrs.